

Installation Guide

PTE5000

Contents

1. General	1
2. Safety Instructions	2
3. Installation and Commissioning	3
4. Technical Data	4
5. Troubleshooting	8
6. Storage, Disposal	9
7. Contact Information	11



1. General

About this Instructions

Carefully read through these installation instructions prior to assembling/installing and commissioning the pressure sensor, keep the instructions in an accessible location for all users. Details about specific applications are not discussed within this document on account of the wide range of general industrial uses of the device.



Indicates an imminent, hazardous situation that can result in severe injury or death if the safety instructions and warnings are not adhered to.



Indicates a potentially hazardous situation that can result in severe injury or death if the safety instructions and warnings are not adhered to.



Indicates a potentially hazardous situation that can result in material damage or minor to serious injury if the safety instructions and warnings are not adhered to.



Information

Indicates important information about the product or about handling of the product.

Special knowledge required

Do not install or commission the pressure sensor unless you are familiar with the country-specific guidelines and codes, and possess the appropriate qualifications.

You must have in-depth knowledge of instrumentation, control technology, and electrical circuits, as the pressure sensor is an item of electrical equipment. Other specialist knowledge may be required for specific applications, i.e. aggressive media.

Intended use



WARNING

The pressure sensor may be used solely for pressure measuring tasks and any directly associated control tasks. Only use the device as described in the instructions to ensure safe operation.

Correct transport, storage, setup and installation and careful use of the pressure sensors is vital for effective, trouble-free operation of the units.

Use of the devices as an "item of equipment with safety-relevant function" and use with Class 1 fluids does not represent intended use and must be evaluated by users at their own discretion (as defined by the Pressure Vessel Directive 97/23/EC).

General hazards on failure to observe the safety notices



WARNING

The device may represent a hazard if it is not used or operated properly.

Any and all persons charged with the installation, commissioning, maintenance or repair of the device must have read and clearly understood the operating instructions and, in particular, the safety notices.

Residual hazards



WARNING

Despite these pressure sensors being constructed to provide the greatest degree of safety, the rules of safety engineering nevertheless demand that burst protection be provided around the sensor.

The sensor must be protected against mechanical loading or impacts.

Exceeding the specified temperature limits, e.g. in a fire, renders the sensor unusable.

2. Safety Instructions



DANGER

Do not open the connections unless they have been depressurized!

Always ensure that the line is depressurized when installing / removing the pressure transmitter.

Only use the pressure sensor within the specified overload limit range!

Observe the operating parameters given under Technical Data. Ensure that the pressure sensor is only used as intended, i.e. as described in the instructions below.

Never tamper with or modify the pressure sensor if such actions are not explicitly described in these operating instructions.

2. Safety Instructions (cont.)



If faults cannot be eliminated, de-activate the pressure sensor and secure it against inadvertent/unauthorized re-activation.

Take all necessary precautions for residual material still in the pressure devices.

This residual material can be hazardous to humans, the environment and the facilities!

Only have repair work performed by the manufacturer.

Prior to installation or commissioning, select the pressure sensing device with the appropriate measuring range, design and specific measuring criteria for the application.

3. Installation and Commissioning



Examine the pressure sensor for any shipping damage. Inform the shipping company and Kavlico immediately of any obvious damage that is detected.

Ensure that the pressure fitting threads and the terminal contacts are not damaged.

Only use the pressure sensor when it is not damaged and in good condition.

Installation - mechanical properties

When installing the device, ensure that the sealing surfaces on the device and at the measuring point are clean and intact.



Screw the device in place at the specified torque, or unscrew it using appropriate tools (e.g. SW27 (WAF) wrench).

The correct torque depends on the pressure fitting and on the seal that is used (geometry/material) and is given in the corresponding thread standard if not otherwise specified. When screwing in the device ensure that the threads are always in line.

When installing the unit, the screw-in torque must not be applied via the housing, the cable entry fitting or the mating connector.

The maximum, permissible tightening torque is 20 Nm.

Installation - electrical connection



Ground the device through the pressure fitting. Use a limited-power circuit as the power supply.

The degree of protection based on the IP safety class (IEC 60 529) applies only when the unit is plugged in with line plugs (sockets) having the corresponding degree of protection. Select the cable diameter as appropriate for the cable entry fitting for the plug. Ensure that the cable gland of the attached plug fits correctly and that all seals are in place and undamaged. Tighten the gland and check for proper seating of the seals.

Check to ensure that no moisture can penetrate into the ends of the cable outlets.



Refer to the technical datasheet for allocation of the different types of plugs and signal output.

Switching of the poles for the sensor plugs for the corresponding mating connector is not possible owing to the clear, unique alignment.

The sensor can be damaged if polarization is not correct when preparing the cable connectors.

Always observe the maximum connected load of 0.5 VDC to +16VDC for output options 0.5-4.5V; 0-5 and 0-10V at the N/C pins.

4. Technical Specifications

Pressure Ranges

from 0 to ...	bar (gage)	6	10	16	25	40	60	100	160	250	400	600
Proof pressure	bar (gage)	12	20	32	50	80	120	200	320	500	800	1200
Burst pressure	bar (gage)	60	100	160	200	320	480	600	960	1000	1600	2400

Physical

Operating Life Cycle	min. 10 million full pressure cycles over the full range
Vibration Resistance	IEC 60068-2-64 (RANDOM) 20 PSD
Shock Resistance	25 g minimum according to DIN EN 60068-2-27
Drop Test	1 meter drop on concrete as per SAE J1455 / DIN EN 60068-2-3-1
Weight	≤ 50 grams (without mating connector)
Ingress Protection	IP 65 or IP67 - depending on electrical connector
Medium Temperature	-30°C to + 120°C (others on request)
Environmental Temperature	-30°C to + 100°C (dep. on electrical connector & external seal ring capability) ^{*4}
Storage Temperature	-30°C to + 100°C (dep. on electrical connector & external seal ring capability) ^{*4}
Media	All class II fluids and gases compatible with stainless steel 304 (1.4301)

^{*4} For more details see How to Order

Performance

Accuracy ^{*1}	≤ 0.5 % of span ^{*3}
Non-linearity ^{*2}	0.2 % of span ^{*3}
Non-repeatability	0.1 % of span ^{*3}
1-year stability	0.2 % of span ^{*3}
Temp. Coefficients - Zero	0.2 % of span / 10 K within temperature range 0°C to + 80°C.2 %
Temp. Coefficients - Span	0.2 % of span / 10 K within temperature range 0°C to + 80°C.2 %

^{*1} Including non-linearity, hysteresis, non-repeatability, zero point and full scale error (corresponds to error of measurement per IEC 61298-2). Adjusted in vertical mounting position with pressure port down.

^{*2} BFSL according to IEC 61298-2 reference conditions to EN 61298-1

^{*3} Others on request

Electrical

Output Signal	4...20 mA	0.5...4.5 VDC ratiometric	0...5 VDC	0...10 VDC
Operating Supply Signal	8-30 VDC * ⁵	5 VDC ± 5% * ⁵	8-30 VDC * ⁵	14-30 VDC * ⁵
Power Consumption	≤ 600 mW	≤ 25 mW	≤ 600 mW	≤ 600 mW
Overvoltage Protection	min. 33 VDC	min. 6 VDC	min. 33 VDC	min. 33 VDC
Short-circuit Proofness	not applicable	Yes * ⁶	Yes * ⁶	Yes * ⁶
Insulation Voltage	500 VDC	500 VDC	500 VDC	500 VDC
Reverse Polarity Protection	Yes * ⁷	Yes * ⁷	Yes * ⁷	Yes * ⁷
Load	≤ (V _{sup} -8 VDC)/(0.02 A) [Ω]	≥ 4.7 kΩ	≥ 4.7 kΩ	≥ 4.7 kΩ
Response Time	≤ 5 ms max. to 63% of full scale pressure with step change on input			

⁵ Unit shall be supplied by a power supply with double/reinforced insulation (SELV) and limited energy in accordance to UL/EN/IEC 61010-1 or LPS in accordance to UL/EN/IEC 60950-1 or class 2 per UL1310/UL1585 (NEC or CEC).
 The power supply shall be approved for usage above 2000m if the pressure sensor is used in this environment. For indoor and outdoor use, not exposed to direct sunlight.
⁶ for min. 3 intervals at 5 minutes each
⁷ for min. 10 seconds on assigned pins

Approvals & Certificates

CE Compliance	Pressure equipment directive 97/23/EC EMC directive 2004/108/EEC, EN 61 326 Emission (Group 1, Class B) and Immunity (industrial locations), EMI, ESD protected
UL	Standard(s) for Safety: Electrical Equipment for Measurement, Control and Laboratory Use - UL 61010-1
ROHS	2011/65/EU ROHS Directive

Dimensions

Pressure Sensor with Electrical Connection

Dimensions in mm [Inch]

M12 Pin Call Outs

Output	Pin 1	Pin 2	Pin 3	Pin 4
4-20 mA	Vsup	...	Iout	...
0.5-4.5 VDC ratiometric	Vsup	...	Vout	GND
0-5 VDC	Vsup	...	Vout	GND
0-10 VDC	Vsup	...	Vout	GND

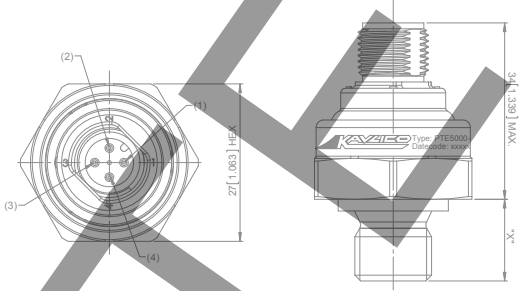

18 mm Pin Call Outs

Output	Pin 1	Pin 2	Pin 3	Pin 4
4-20 mA	Vsup	Iout
0.5-4.5 VDC ratiometric	Vsup	Vout	GND	...
0-5 VDC	Vsup	Vout	GND	...
0-10 VDC	Vsup	Vout	GND	...

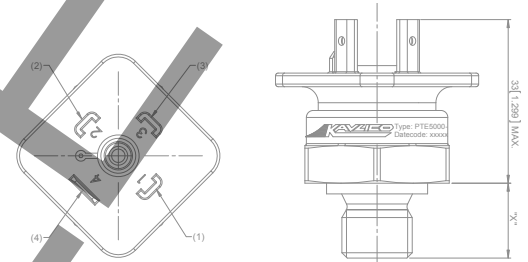

Packard (metri-pack 150) Pin Call Outs

Output	Pin 1	Pin 2	Pin 3
4-20 mA	Iout	Vsup	...
0.5-4.5 VDC ratiometric	GND	Vsup	Vout
0-5 VDC	GND	Vsup	Vout
0-10 VDC	GND	Vsup	Vout

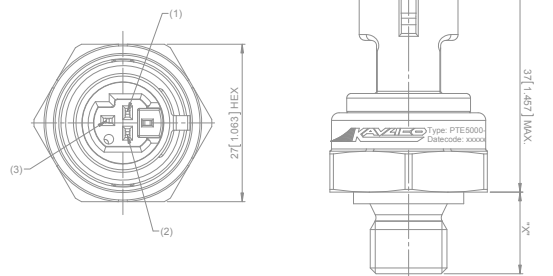

9.4 mm Pin Call Outs

Output	Pin 1	Pin 2	Pin 3	Pin 4
4-20 mA	Vsup	Iout
0.5-4.5 VDC ratiometric	Vsup	Vout	GND	...
0-5 VDC	Vsup	Vout	GND	...
0-10 VDC	Vsup	Vout	GND	...

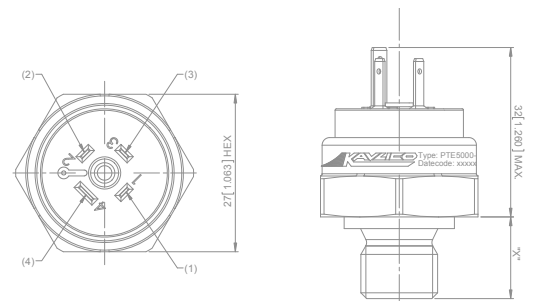

Pressure Connections and Recommended Installation Torque

Dimensions in mm [Inch]

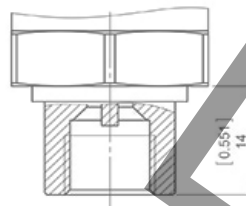
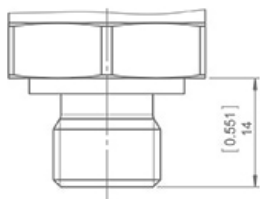

Name	G1/4A DIN 3852-E	7/16-20 UNF-2B SAE J1926-1
Thread	External	Internal
Torque	20 Nm	20 Nm

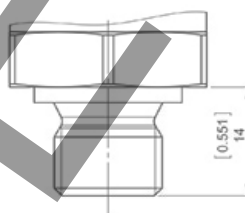
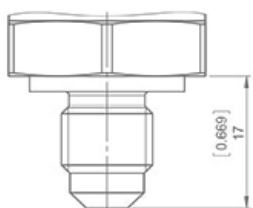

Name	7/16-20 UNF-2A SAE J1926-2	G1/4A DIN 3852-A
Thread	External	External
Torque	20 Nm	20 Nm

5. Troubleshooting

Do not open the connections unless they have been depressurized! The pressure sensor is maintenance-free. Only have repair work performed by the manufacturer.

Never use any sharp, pointed or hard objects to clean the device, as this could damage the sensitive membrane of the pressure fitting.



Take all necessary precautions with any residual material removed from the pressure sensor. This residual material can be hazardous to humans, the environment and the facilities!

If faults cannot be eliminated, de-activate the pressure sensor and secure it against inadvertent/unauthorized re-activation.

Symptom	Cause	Action
No output signal	Open Circuit	Check for continuity
Deviating zero-point signal	Overload limit exceeded	Maintain permissible overload limit (see Technical Data)
Deviating zero-point signal	Operating temperature too high/ low	Maintain permissible temperature range (see Technical Data)
Constant output signal on change in pressure	Mechanical overloading due to excessive pressure	Replace device; consult manufacturer on repeated failure of device
Signal span too narrow	Mechanical overloading due to excessive pressure	Replace device; consult manufacturer on repeated failure of device
Signal span fluctuates	EMC disturbance sources in the vicinity, e.g. Frequency converters	Shield the device; wire sheath; remove source of disturbance
Signal span fluctuates/not precise	Operating temperatures too high/low	Maintain permissible temperature range (see Technical Data)
Signal span drops/too narrow	Damage to membrane, e.g. By impact, abrasive/aggressive medium; corrosion on membrane/pressure fitting; lack of transfer medium	Consult the manufacturer and replace the device

Contamination Declaration for Service (Process Material Certificate)

Rinse out and/or clean devices that have been removed before returning them to protect our employees and the environment from the hazards posed by adherent residual material in the device. Devices that have failed can only be examined safely and thoroughly when an in-depth description is provided detailing the fault and how the device is used. This description must list all the materials that the device has come into contact with, including those used for testing, during operation or for cleaning.

6. Storage, Disposal



Take appropriate precautionary measures for storage and disposal for residual materials in pressure sensing devices that have been removed. We recommend performing thorough cleaning in accordance with the measuring equipment used. Residual material in the device can be hazardous to humans, the environment and the facilities! Dispose of the device components and packing materials in compliance with the pertinent, country specific waste handling and disposal codes in the country to which the device is delivered.

Part Number Designation

PTE5000

060

2

B

1

A

Pressure Ranges Bar

006	0 – 6
010	0 – 10
016	0 – 16
025	0 – 25
040	0 – 40
060	0 – 60
100	0 – 100
160	0 – 160
250	0 – 250
400	0 – 400
600	0 – 600

Output

1	4 - 20 mA
2	0.5 – 4.5 VDC ratiometric
3	0 – 5 VDC
4	0 – 10 VDC

External O-ring

- A None
- B Fluorocarbon FKM (Viton)
only for pressure port option 1
lower temperature limited to -20°C
- C Aluminium Washer G1/4
only for pressure port option
washer will be fixed with plastic cap
- D Copper Washer G1/4
only for pressure port option
washer will be fixed with plastic cap

Built-in Electrical Connection

- A Compatible with DIN 175301-803 A (18 mm)
Sensor delivered without mating connector
- B GDS 307 Industrial Standard (9.4 mm)
Sensor delivered without mating connector
- C M12 - 4 pole
Sensor delivered without mating connector
- D Packard Metri-Pack 150
Sensor delivered without mating connector

Pressure Connection (port)

- 1 G1/4" A DIN 3852-E
- 2 7/16"-20 UNF-2B (female) SAE J1926/1 (modified)
with 45° cone and schrader. only for pressure range 006 - 060
- 3 7/16"-20 UNF-2A (male) SAE J1926/2 (modified)
with 45° cone, only for pressure range 006 - 060
- 4 G1/4" A DIN 3852-A

Example:

PTE5000 -060 - 2 - B - 1 - A

Description:

PTE5000 Sensor, 0 - 60 Bar Gage, 0.5 - 4.5 VDC Ratiometric Electrical Output, Fluorocarbon FKM (Viton) External O-Ring, G1/4" A DIN 3852-E Pressure Connection, with Built-in Connector Compatible with DIN175301-803 A (18mm)

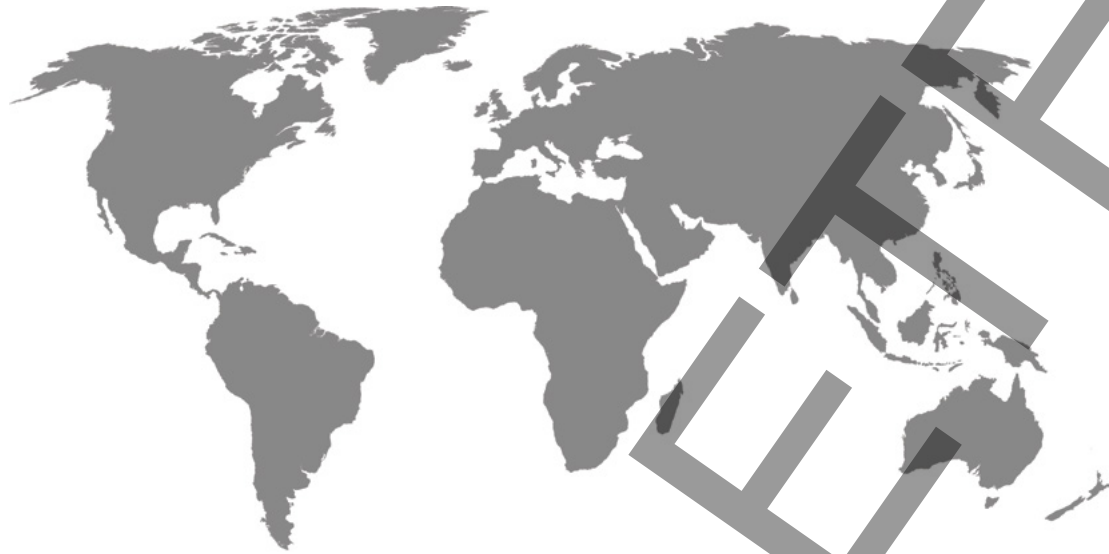

Sales Offices Worldwide

Americas

Brazil
Mexico
USA

Europe

England
France
Germany
Italy
Netherlands
Spain
Sweden
Russia

Asia Pacific

China
India
Japan
South Korea

Main Contact

Sensata Germany GmbH
Potsdamer Strasse 14,
32423 Minden
Tel: +49 571 3859-0
Fax: +49 571 3859-119
www.kavlico.com
www.sensata.com

Your local sales contact: